

oslo

art.
301

Projectors

Recessed

Contemporary

Traditional



corpo alluminio pressofuso
 body in die casting aluminium
 corps en aluminium moulé
 sous pression
 cuerpo aluminio inyectado
 Körper aus Aluminium-
 Druckguss

diffusore vetro
 diffuser glass
 diffuseur verre
 difusor vidrio
 Diffuser Glas

dettagli / details / details detalles / details:
 p.164-165

FOR TECHNICAL DETAILS VISIT
www.landa.it

IP43

ELECTRIFICATION



Energy efficiency classes

example code:

art.	finishing	size	colour
301	.	02	ngg

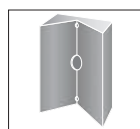
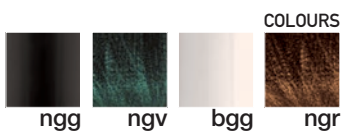
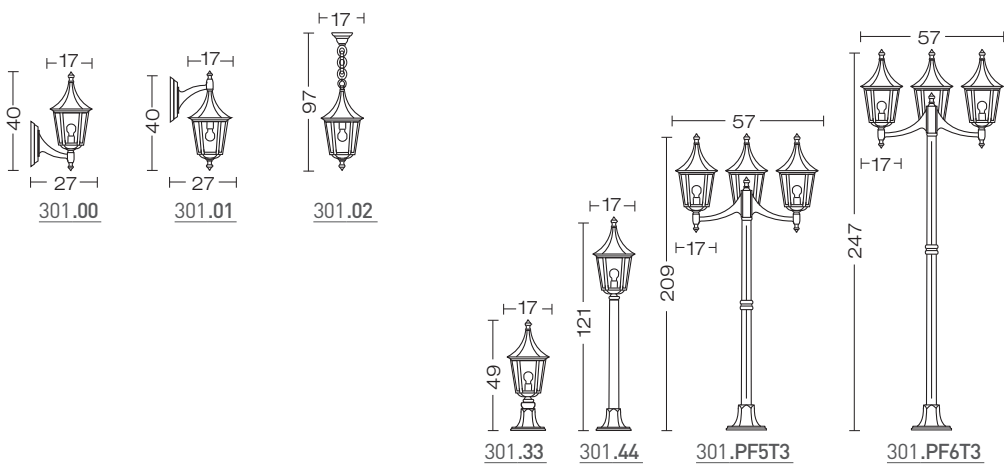

00108

angoliera
 corner bracket
 patte d'angle
 esquinera
 Eckhalterungen

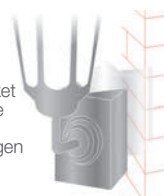

esempio di fissaggio
 fixing example
 exemple de fixation
 ejemplo de fijación
 Beispiel von Fixierung

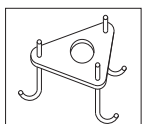

Anchor Bolt:
 code 00APF6

Accessories on request:



code 0404M004
 Single connection IP68



code 0404M003
 Loop in loop out IP68

max 60 W



max 23 W

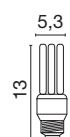

E27

max 15 W

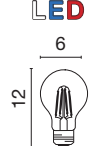

A+ ÷ E